

Sleeping Shelter small 40 (165x238) 2021

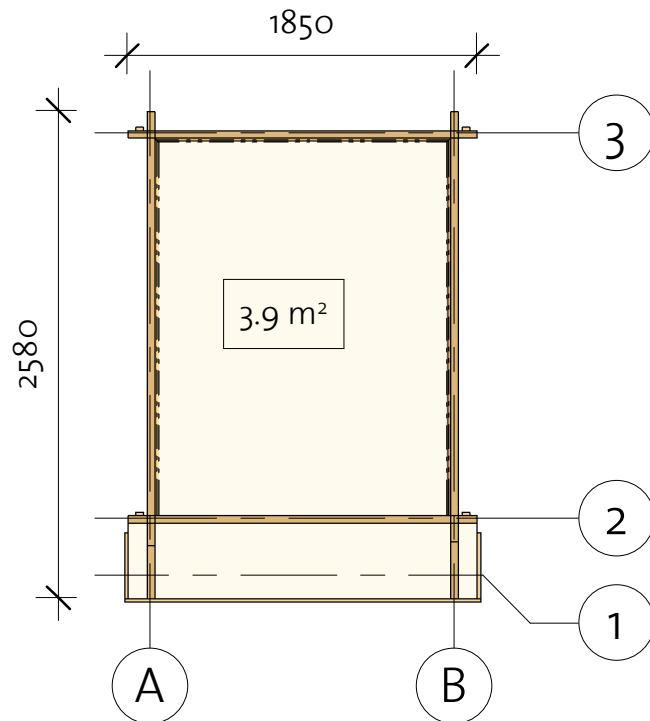

Sleeping Shelter small 40 (165x238) 2021

Foundation

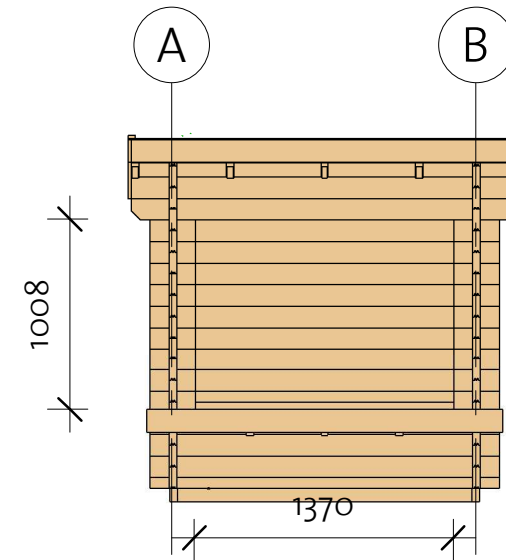
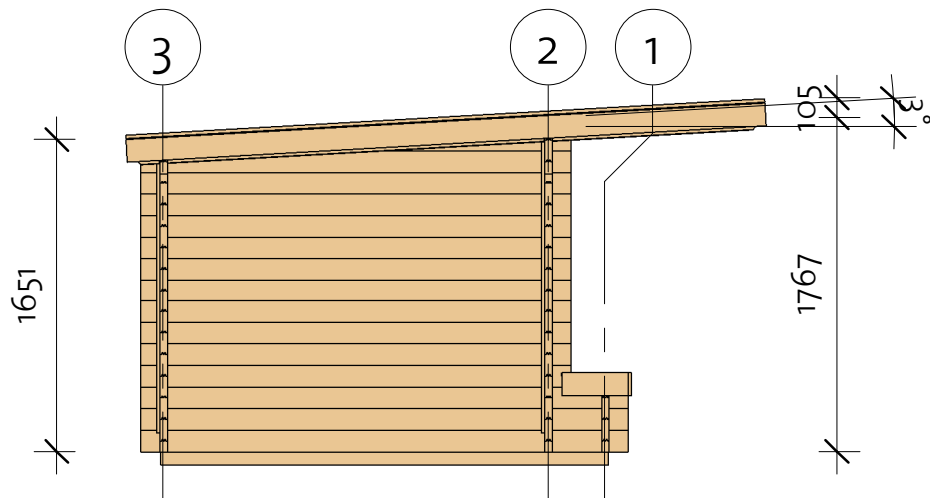
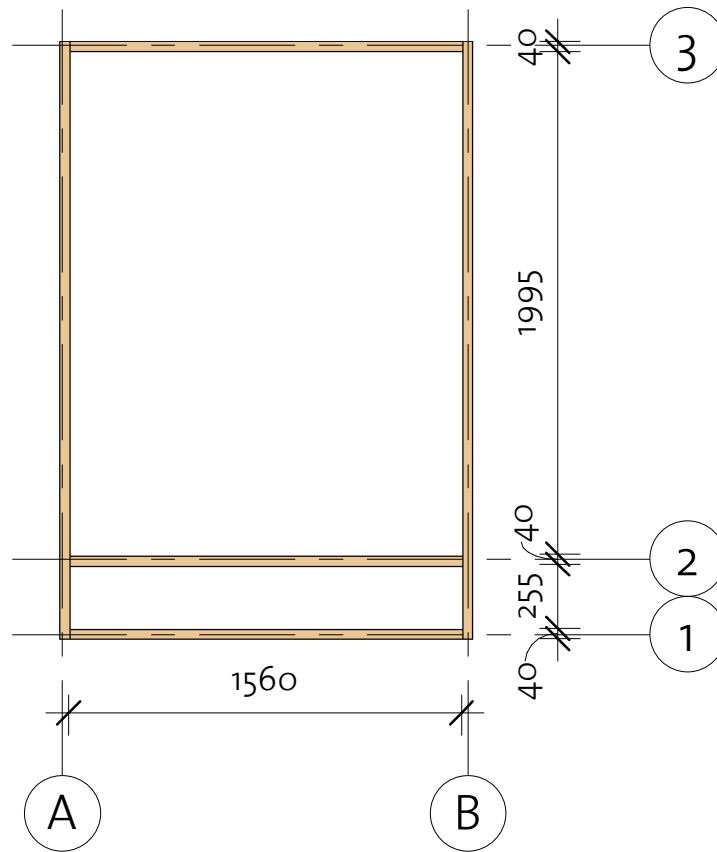

Impregnated foundation beams				
Mark	Type	Profile	Count	Length
IFB1	IFB 40x70		3	1560
IFB2	IFB 40x70		2	2370

Sleeping Shelter small 40 (165x238) 2021

Floor Plan

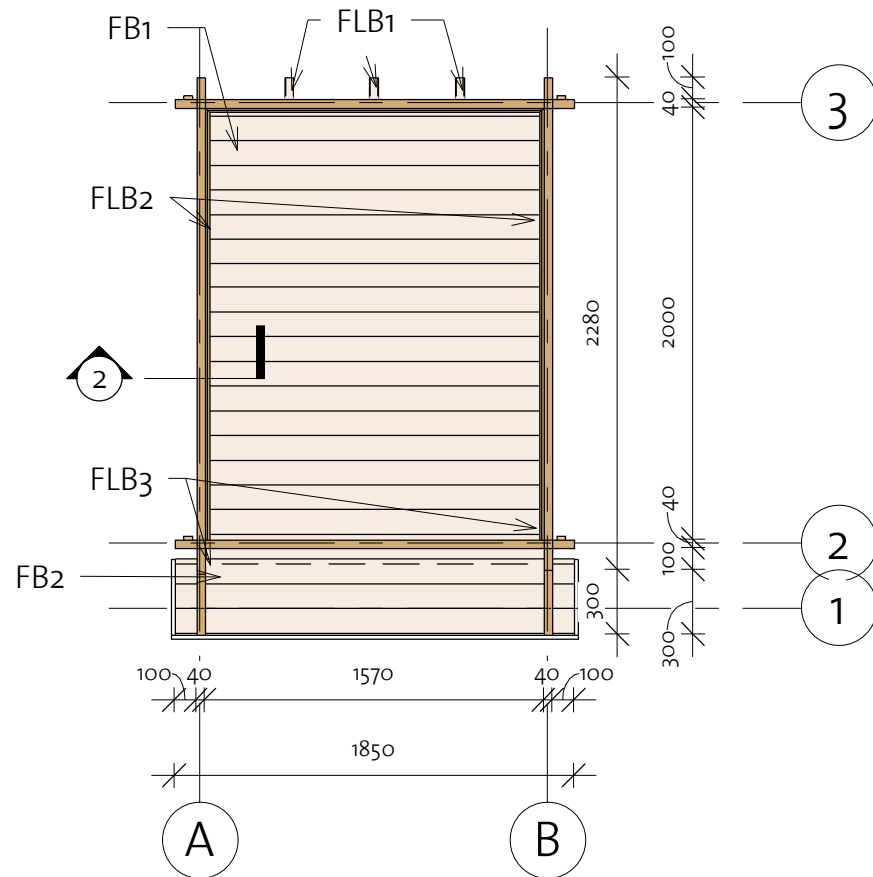



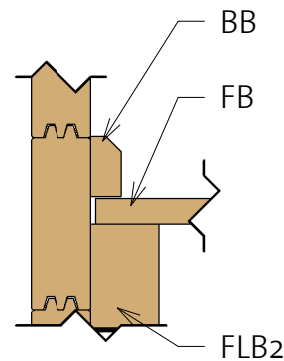

BB1	BB 20X40		1	1700
BB2	BB 20X40		2	2000



Floor Schedule

Mark	Type	Profile	Count	Length
------	------	---------	-------	--------

FB1	FB 17x114		20	1567
FB2	FB 17x114		3	1850
FLB1	Floor beam 40x120		3	2580
FLB2	Floor beam 40x70		2	1960
FLB3	Floor beam 40x70		2	260

91809071_210506

Sleeping Shelter small 40 (165x238) 2021

Wall 1

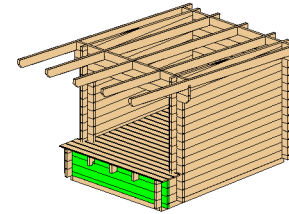

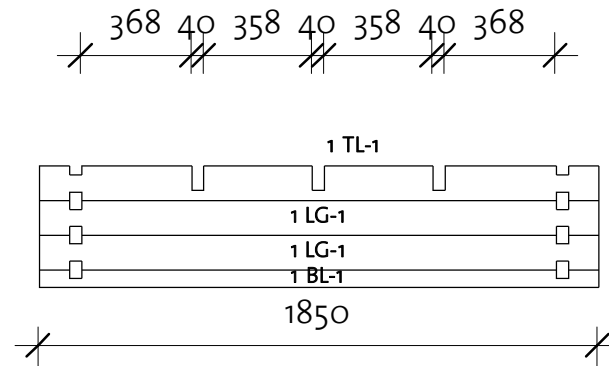

Wall 1			
Mark	Profile	Count	Cut Length

1BL-1	40X57	1	1850
1LG-1	40X114	2	1850
1TL-1	40X114	1	1850

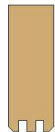

Log Profile Wall 1	
Profile	Profile

40X57	
40X114	
40X114	

Sleeping Shelter small 40 (165x238) 2021

Wall 2

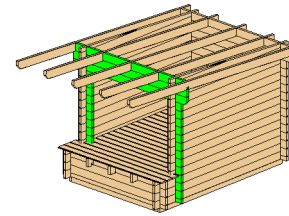

Wall 2			
Mark	Profile	Count	Cut Length

2BL-1	40X57	1	1850
2LG-1	40X114	18	240
2LG-2	40X114	2	1850
2LG-3	40X114	1	1850
2LG-4	40X114	1	2050
2LG-5	40X114	1	2050
2TL-1	40X114	1	2050

Log Profile Wall 2	
Profile	Profile

40X57	
40X114	
40X114	

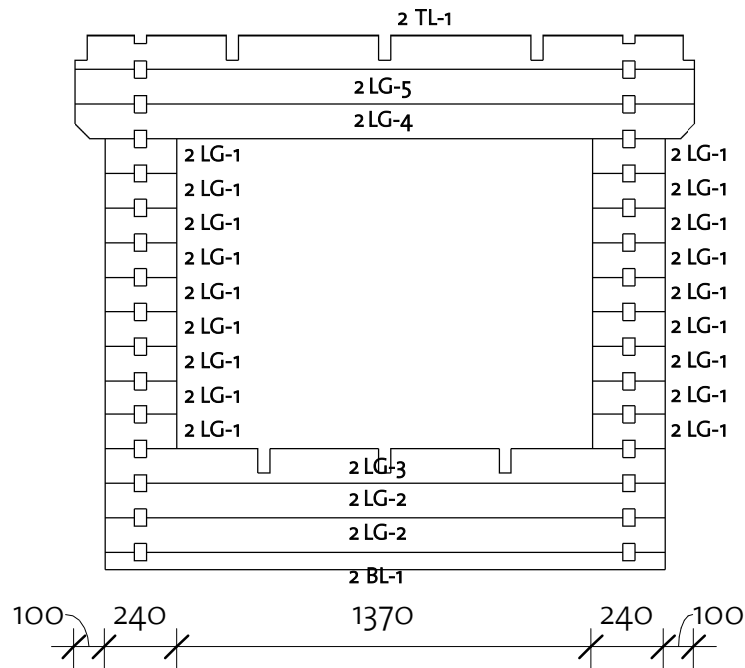

Sleeping Shelter small 40 (165x238) 2021

Wall 3

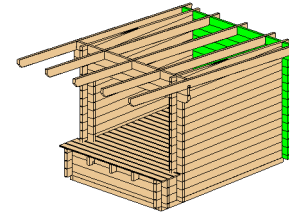

Wall 3			
Mark	Profile	Count	Cut Length

3BL-1	40x57	1	1850
3LG-1	40x114	11	1850
3LG-2	40x114	1	1850
3LG-3	40x114	1	2050
3TL-1	40x112	1	2050

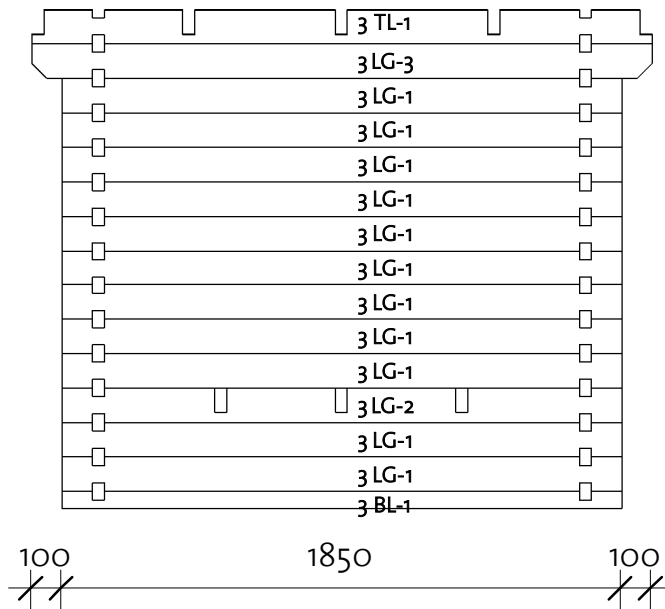

Log Profile Wall 3	
Profile	Profile

40x57	
40x114	
40x112	

Sleeping Shelter small 40 (165x238) 2021

Wall A

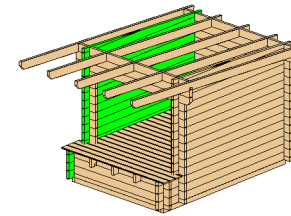

Wall A			
Mark	Profile	Count	Cut Length

ALG-1*	40x114	1	1100
ALG-2*	40x114	1	2280
ALG-3	40x114	10	2280
ALG-4	40x114	1	2580
ALG-5	40x114	3	2580

* Gable - delivered premounted

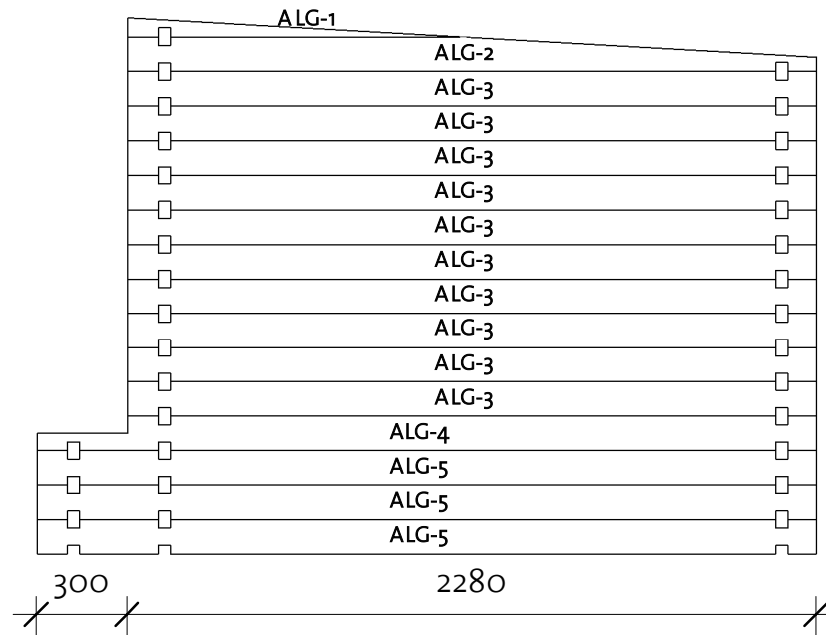

Log Profile Wall A	
Profile	Profile

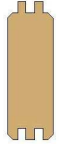
40x114	
--------	---

Sleeping Shelter small 40 (165x238) 2021

Wall B

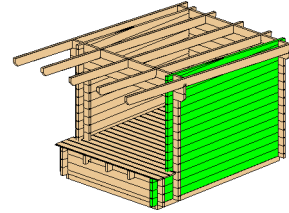

Wall B			
Mark	Profile	Count	Cut Length

BLG-1*	40x114	1	1100
BLG-2*	40x114	1	2280
BLG-3	40x114	10	2280
BLG-4	40x114	1	2580
BLG-5	40x114	3	2580

* Gable - delivered premounted

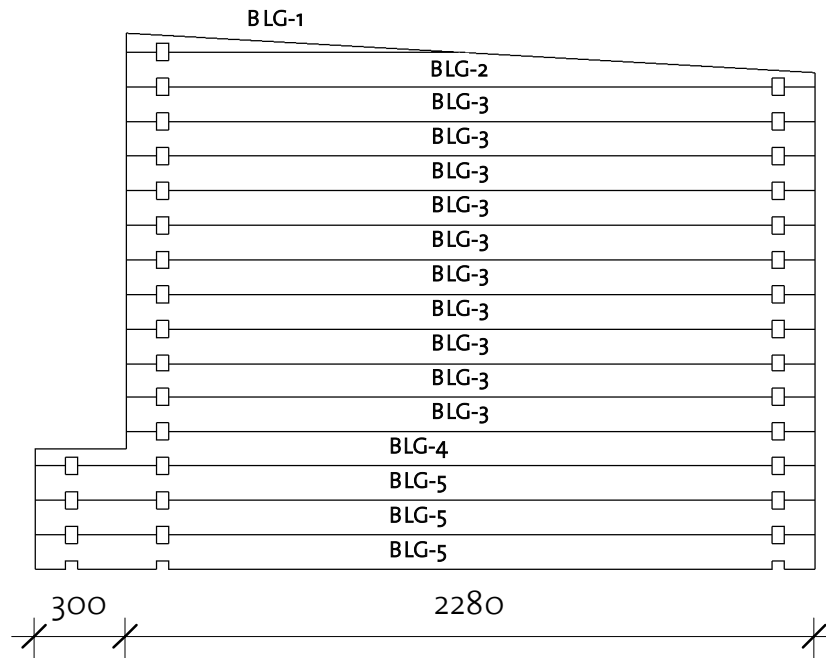

Log Profile Wall B	
Profile	Profile

40x114	
--------	--

Sleeping Shelter small 40 (165x238) 2021

Roof 1

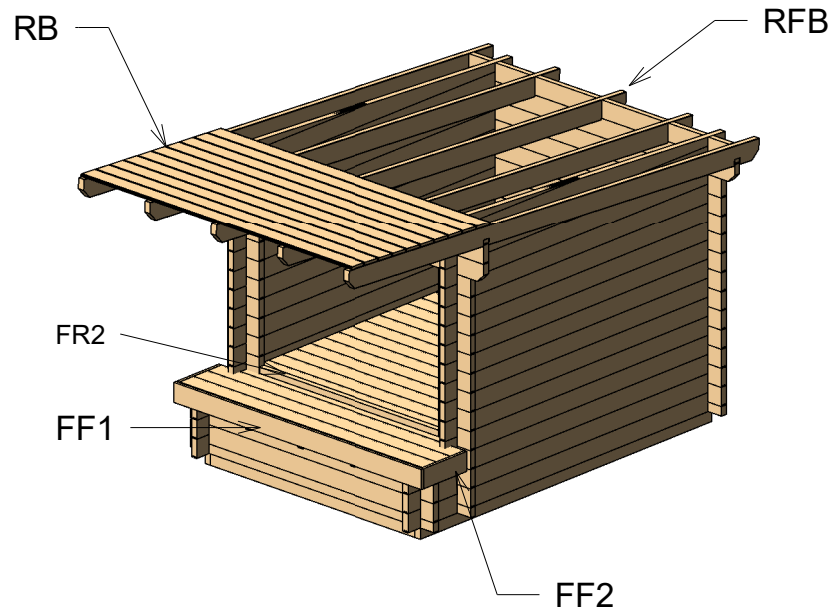

① Floor Facia

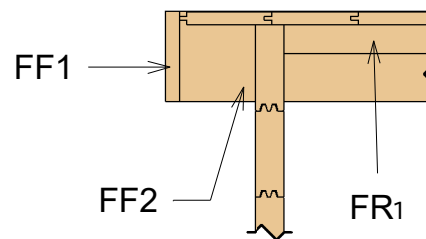

Roof				
Mark	Type	Profile	Count	Length

RFB	Beam 40x120		5	3350
RB	17x114		31	2050



Floor Facia				
Mark	Type	Profile	Count	Length

FF1	Floor Facsia 18x120		1	1886
FF2	Floor Facsia 18x120		2	350
FR1	Floor reinforcement 38x38		2	190
FR2	Floor reinforcement 38x38		1	1370

Sleeping Shelter small 40 (165x238) 2021

Roof 2

Fascia Schedule				
Mark	Type	Profile	Count	Length

EE	Eave Edging 18x40		2	3386
RF1	Roof Fascia 18x120		2	3386
RF2	Roof Fascia 18x120		2	2050

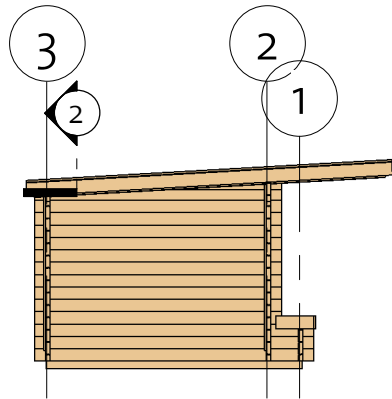

② Facia

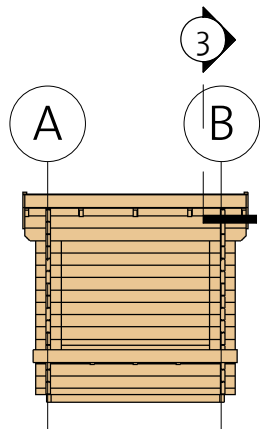
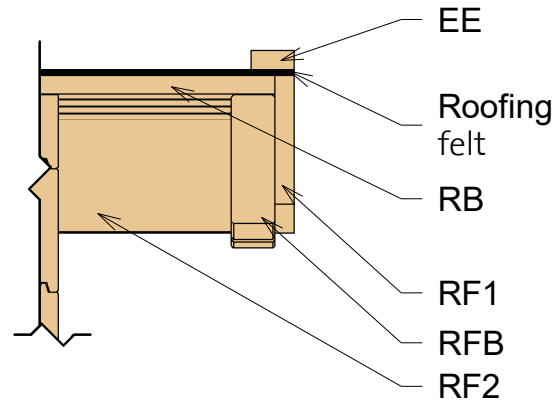

③ Roof Reinforcement

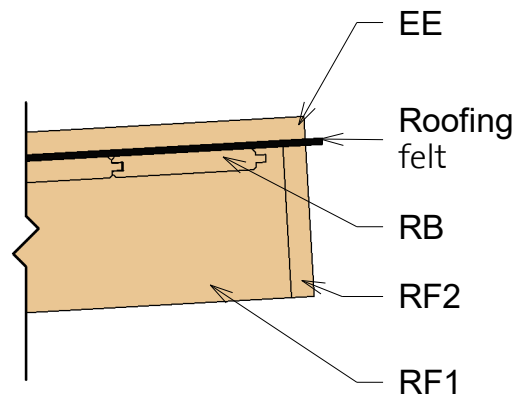

Sleeping Shelter small 40 (165x238) 2021

Extras

Fasteners/Extras		
Name	Type	Count

Hitblock	300-400 mm	
Bolts	M8x70	12
Nails	1,4 x 40	15
Screws	5,0x 70	35
Screws	4,0 x 40	50
Screws	6,0 x 140	50
Screws	4,0 x 50	320







Type	Count	Length
------	-------	--------





Windboard 2 18x40	2	1520
Windboard1 18x40	2	1650

Sleeping Shelter small 40 (165x238) 2021

List of all items 1





Roof				
Mark	Type	Profile	Count	Length
RFB	Beam 40x120		5	3350
RB	17x114		31	2050



Fascia Schedule				
Mark	Type	Profile	Count	Length
EE	Eave Edging 18x40		2	3386
RF1	Roof Fascia 18x120		2	3386
RF2	Roof Fascia 18x120		2	2050

Floor Schedule				
Mark	Type	Profile	Count	Length
FB1	FB 17x114		20	1567
FB2	FB 17x114		3	1850
FLB1	Floor beam 40x120		3	2580
FLB2	Floor beam 40x70		2	1960
FLB3	Floor beam 40x70		2	260

Sleeping Shelter small 40 (165x238) 2021

List of all items 2

Floor Facia				
Mark	Type	Profile	Count	Length
FF1	Floor Facsia 18x120		1	1886
FF2	Floor Facsia 18x120		2	350
FR1	Floor reinforcement 38x38		2	190
FR2	Floor reinforcement 38x38		1	1370

Impregnated foundation beams				
Mark	Type	Profile	Count	Length
IFB1	IFB 40x70		3	1560
IFB2	IFB 40x70		2	2370

Sleeping Shelter small 40 (165x238) 2021

List of all items 3

Wall 1			
Mark	Profile	Count	Cut Length

1BL-1	40X57	1	1850
1LG-1	40X114	2	1850
1TL-1	40X114	1	1850

Wall 2			
Mark	Profile	Count	Cut Length

2BL-1	40X57	1	1850
2LG-1	40X114	18	240
2LG-2	40X114	2	1850
2LG-3	40X114	1	1850
2LG-4	40X114	1	2050
2LG-5	40X114	1	2050
2TL-1	40X114	1	2050

Wall 3			
Mark	Profile	Count	Cut Length

3BL-1	40X57	1	1850
3LG-1	40X114	11	1850
3LG-2	40X114	1	1850
3LG-3	40X114	1	2050
3TL-1	40X112	1	2050

Log Profiles	
Profile	Profile

40X114	
--------	---

Wall A			
Mark	Profile	Count	Cut Length

ALG-1*	40X114	1	1100
ALG-2*	40X114	1	2280
ALG-3	40X114	10	2280
ALG-4	40X114	1	2580
ALG-5	40X114	3	2580

Wall B			
Mark	Profile	Count	Cut Length

BLG-1*	40X114	1	1100
BLG-2*	40X114	1	2280
BLG-3	40X114	10	2280
BLG-4	40X114	1	2580
BLG-5	40X114	3	2580

* Gable - delivered premounted

Log Profiles	
Profile	Profile

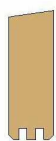
40X57	
40X112	

Log Profiles	
Profile	Profile

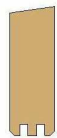
40X114	
40X114	